

Intraoral Appliances

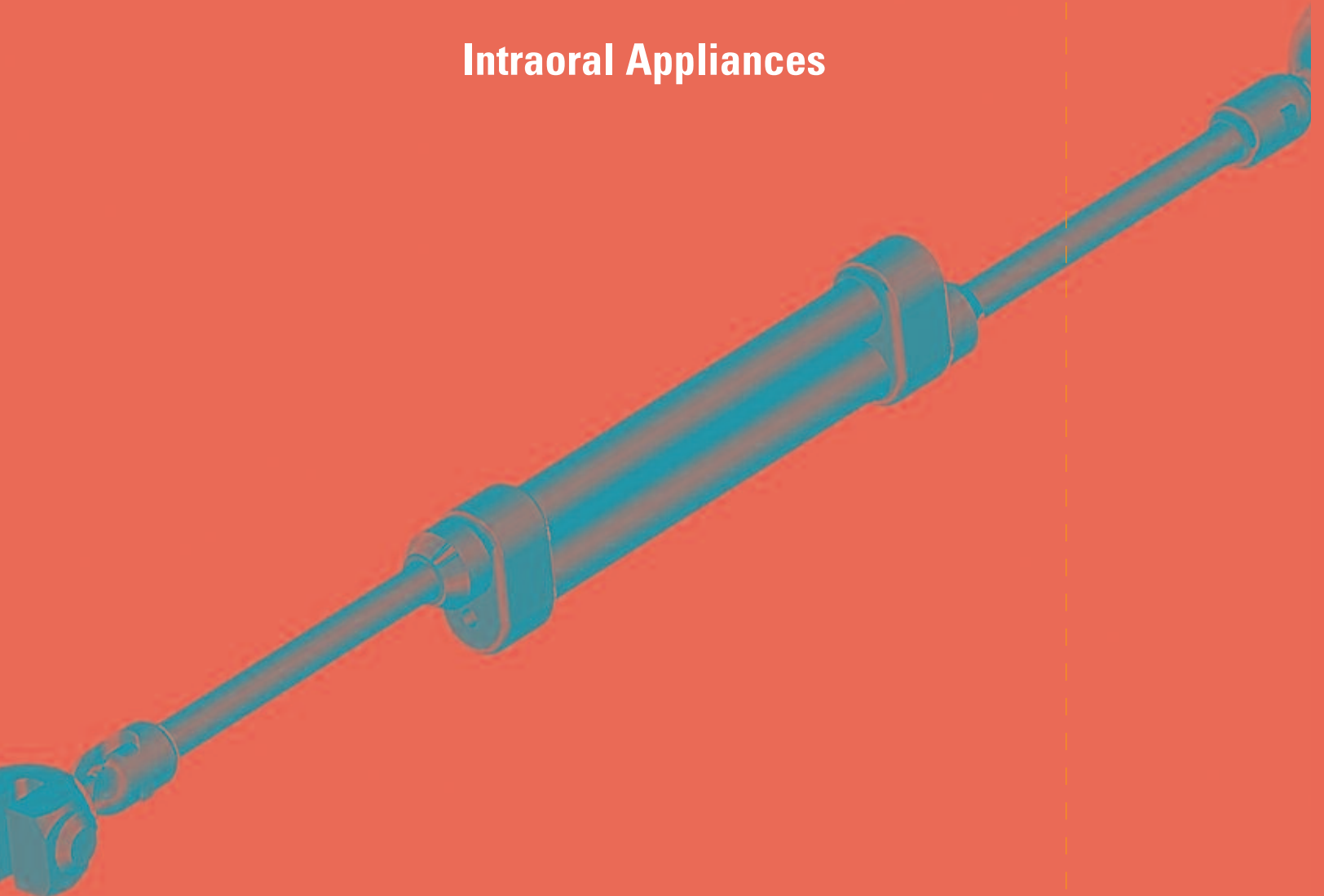

Intraoral Appliances

Nitanium® Palatal Expander2™ and Nitanium® Molar Rotator2™

These appliances are pre-programmed so they dramatically improve on conventional expanders and rotators. They revolutionize palatal expansion.

Precise Metal Injection Molding (MIM) Components

The Nitanium® Palatal Expander2™ and Nitanium® Molar Rotator2™ feature stainless steel components created by the Metal Injection Molding (MIM) process.

Thermally Activated for Total Control!

The easy to use Nitanium® Palatal Expander2™ takes expansion a step beyond. This expansion appliance has the capacity to rotate, upright, distalize and expand anterior and posterior.

The Nitanium® Palatal Expander2™ action is the result of transition temperature and shape memory. Warmth from the patient's mouth activates movement in the thermal nickel titanium energy wire toward the appliance's pre-programmed shape, producing the desired expansion and in unison tooth movement. Once exact correction is achieved, the appliance stops expanding and lies passive.

For patients requiring upper first molar rotation, we also offer the thermally activated Nitanium® Molar Rotator2™.

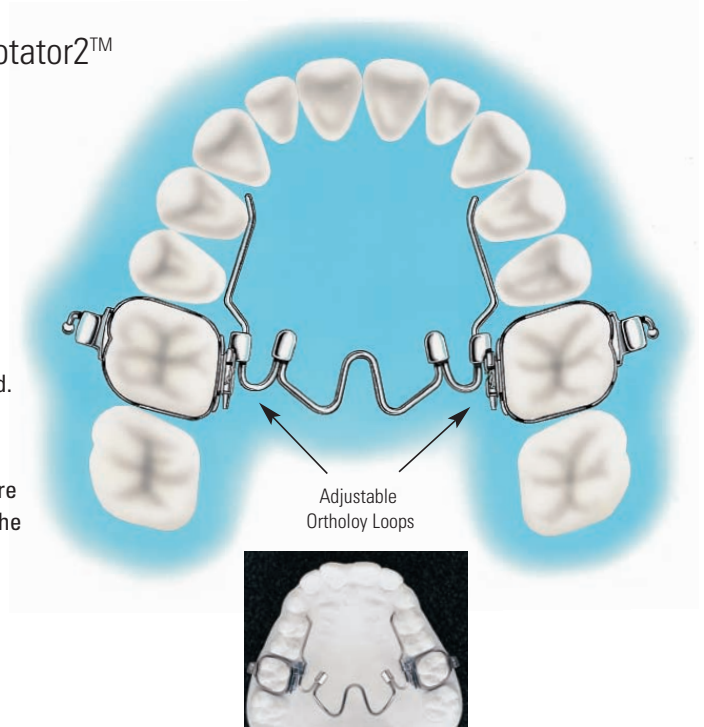

Patient #96807 Progress

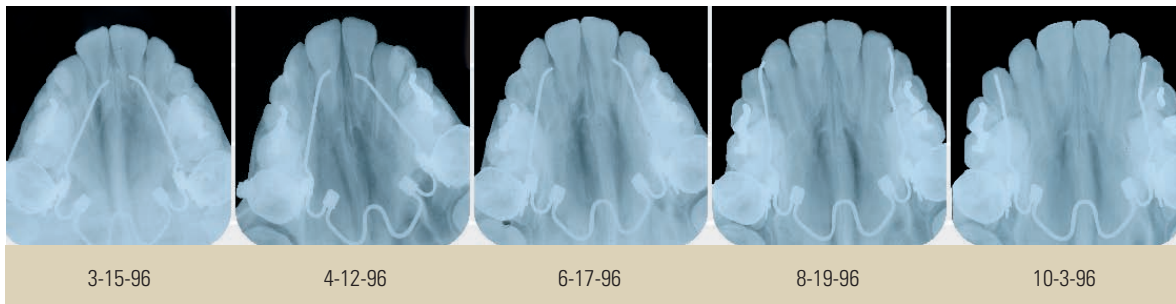

Ask for Your Free Copy of these Articles on Nitanium® Palatal Expander2™

“Slow Maxillary Expansion with Nickel Titanium”

Drs. Ravi Nanda and Robert Marzban • 999-162

“Slow and Continuous Maxillary Expansion, Molar Rotation and Molar Distalization”

Dr. Maurice Corbett • 999-151

Nitanium® Palatal Expander2™

For easy identification, each expander has permanently stamped size numbers on the assembly. Expanders are for single use only.



Full Range Kit • 101-760

- 1 expander of each of the following 10 sizes:
26mm, 28mm, 30mm, 32mm, 34mm,
36mm, 38mm, 40mm, 42mm and 44mm.
- 1 can of Ortho Freez (10 oz.)
- 1 acrylic storage rack
- Instruction manual



NPE2™ Full-Range Kit • 101-760



Mid-Range Kit • 101-760M

- 1 expander of each of the following 5 sizes:
32mm, 34mm, 36mm, 38mm and 40mm.
- 1 can of Ortho Freez (10 oz.)
- 1 acrylic storage rack
- Instruction manual

Individual Expanders (1 per pack)

- | | |
|-------------------------|-------------------------|
| 26mm expander • 101-761 | 36mm expander • 101-766 |
| 28mm expander • 101-762 | 38mm expander • 101-767 |
| 30mm expander • 101-763 | 40mm expander • 101-768 |
| 32mm expander • 101-764 | 42mm expander • 101-769 |
| 34mm expander • 101-765 | 44mm expander • 101-770 |

NPE2™ Mid-Range Kit • 101-760M



NPE2™ Rack • 120-015



Ortho Freez (10 oz.) • 100-788

Individual Components

- Ortho Freez (10 oz. can) • 100-788
- Expander Adjustment Plier • 200-450
- .036 Lingual Sheath (fits left or right) (10 per pack) • 971-032

Nitanium® Molar Rotator2™

For easy identification, each rotator has permanently stamped size numbers on the assembly. Rotators are for single use only.

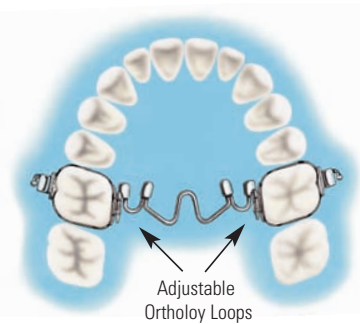

Individual Rotators (1 per pack)

- | | |
|------------------------|------------------------|
| 26mm Rotator • 101-781 | 28mm Rotator • 101-782 |
| 30mm Rotator • 101-783 | 32mm Rotator • 101-784 |
| 34mm Rotator • 101-785 | 36mm Rotator • 101-786 |
| 38mm Rotator • 101-787 | 40mm Rotator • 101-788 |
| 42mm Rotator • 101-789 | 44mm Rotator • 101-790 |

Full Range Kit • 101-780

- 1 Rotator of each of the following 10 sizes:
26mm, 28mm, 30mm, 32mm, 34mm,
36mm, 38mm, 40mm, 42mm, and 44mm.
- 1 can of Ortho Freez (10 oz.)
- 1 acrylic storage rack
- Instruction manual



Individual Components

- Ortho Freez (10 oz. can) • 100-788
- Expander Adjustment Plier • 200-450
- .036 Lingual Sheath (fits left or right) (10 per pack) • 971-032

For Direct Bond Lingual Sheaths see page 51.

Ortho Patent No. 5,816,800 Patented Design: 5,399,087,35,170 and 5,538,422 under sub-license from Ultimate Wireforms, U.S.A.

Palatal Bar

Stainless steel palatal bar is designed to fit .036 lingual sheath and provide control of upper first molars. (5 per pack)

34mm • 033-091 45mm • 033-094
 37mm • 033-092 47mm • 033-095
 41mm • 033-093 Kit (contains 4 of each size) • 033-090

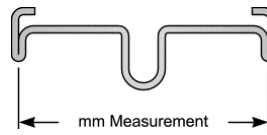

Kit • 033-090

CNA™ Reverse (Mesial) Loop Palatal Bar

Designed to control upper first molars with gentle biocompatible force, the loop is reversed to point toward the anterior of the palate reducing patient gag reflex. The Palatal Bar design fits .036 lingual sheaths and provides control of upper first molars. (5 per pack)

34mm • 033-191 41mm • 033-193 47mm • 033-195
 37mm • 033-192 45mm • 033-194 Kit (contains 2 of each size) • 033-190

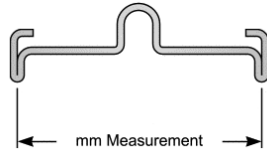

Kit • 033-190

Adams Clasp Kit & Components

Provides the ultimate in retention. Preformed convenience eliminates tedious forming and bending. Machine set 20° angle loop guarantees better interproximal grip without interference to adjacent teeth. Easy to adjust. Eight sizes for bicuspids and molars.

Adams Clasp Kit • 032-070

Assortment of 100 clasps, inventoried by frequency of use. Packed in dispenser/storage box.



Kit • 032-070

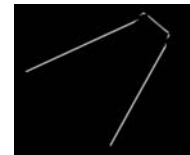

Individual Clasps

Sizes are measured midline of loop to midline of loop. (10 per pack)

5mm • 032-071 7mm • 032-073 9mm • 032-075 11mm • 032-077
 6mm • 032-072 8mm • 032-074 10mm • 032-076 12mm • 032-078

Keller Appliance System

The correction of orthopedic and orthodontic problems is facilitated by this appliance. (Appliance fabrication manual is available upon request).

Components

Maxillary 1st Molar Double Lingual Tube .036 x .072 Tube accommodates Keller wire plus palatal bar. Can be welded to preformed bands. (10 per pack)

Upper Right • 937-085 Upper Left • 937-084

Single Lingual Tube (Upper or Lower) .036 (6mm)

Can be welded to preformed bands. (10 per pack)

Upper or Lower • 937-080

Lingual Wire

.032 Threaded stainless steel wire with four brass compression nuts. (2 per pack) Lingual Wire • 033-080

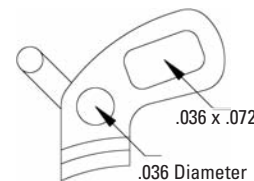

Kit contains:

Maxillary 1st Molar Double Lingual Tubes (5 Lefts, 5 Rights), Single Lingual Tubes (10), Lingual Wires with 4 Nuts (10), Palatal Bars (2 each: 34mm, 37mm, 41mm, 45mm, 47mm), Open Coil Spring (1 Spool - .010 x .036)

Starter Kit • 033-070

Fixed Lingual Controlled Arch

Can be used for applications such as control of rotation, uprighting and stabilization and space maintenance. A simple fixed "U" shaped stainless steel appliance that fits into standard .036" x .027" horizontal lingual sheaths. Available in sizes 1 through 4. Use in maxillary or mandibular arches. (5 per pack)

Size 1 • 032-061
 Size 2 • 032-062
 Size 3 • 032-063
 Size 4 • 032-064
 Kit (contains 5 of each size) • 032-060

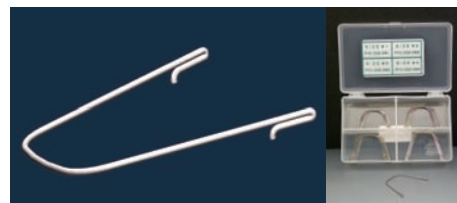

The Multi-Distalizing Arch™ (MDA) Complete Distalizing Systems

A Fixed Appliance for Nonextraction Cases

Permits nonextraction treatment even in severely crowded cases by allowing distal movement for creating space. The teeth are moved bodily and do not tip. This distalizing arch is not phase dependent, so it's excellent for mixed dentition cases. The appliance is also not dependent on age or growth for producing dramatic results. As a fixed appliance, it greatly enhances treatment results by minimizing the need for patient cooperation and the possibility of lost or broken appliances.

Virtually Eliminates Severe Crowding

First and second molars can be distalized up to 8 or 10 millimeters without tipping. This large gain in space virtually eliminates severe crowding.

An Appliance with True Multi-Treatment Capability

The Multi-Distalizing Arch™ is a true multi-treatment appliance. Use it for bilateral, unilateral, maxillary or mandibular distalization. The MDA can also correct asymmetrical malocclusions.

Eliminates Functionals and Headgear

The Multi-Distalizing Arch™ eliminates the need for functional appliances and/or headgear to correct skeletal discrepancies.



The Pro Form™ arch shape incorporates a rectangular .016 x .022 anterior wire that activates torquing forces earlier in treatment. The length of active treatment is more predictable because of the utilization of fixed interarch mechanics.

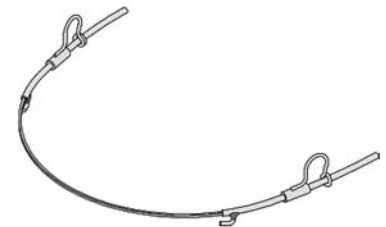

The Pro Form™ Arch shape with fixed rectangular .016 x .022 anterior wire and .042 distal wires (fit .045 facebow tubes) incorporates a rectangular anterior wire that will activate torquing forces earlier in treatment. The appliance is also useful in retracting and intruding maxillary and anterior teeth when desired. Midline is marked. Distal loops are adjustable. Multi-Distalizing Arches are for single use only.

Individual Distalizers

Size 1	80mm MDA (2 per pack)	• 424-155	Size 6	95mm MDA (2 per pack)	• 424-160
Size 2	83mm MDA (2 per pack)	• 424-156	Size 7	98mm MDA (2 per pack)	• 424-161
Size 3	86mm MDA (2 per pack)	• 424-157	Size 8	101mm MDA (2 per pack)	• 424-161B
Size 4	89mm MDA (2 per pack)	• 424-158	Size 9	104mm MDA (2 per pack)	• 424-161C
Size 5	92mm MDA (2 per pack)	• 424-159			

Kit Contains:

1 distalizer each of the following 7 sizes:

- Size 1 80mm
- Size 2 83mm
- Size 3 86mm
- Size 4 89mm
- Size 5 92mm
- Size 6 95mm
- Size 7 98mm

Multi-Distalizing Kit • 424-150

Individual Components (sold separately)

- Omega Adjustable Stop (10 pack) • 424-163
- All sizes below come 1 per package
- Size 1 Basic Distalizing Arch (no omega) • 424-164
- Size 2 Basic Distalizing Arch (no omega) • 424-165
- Size 3 Basic Distalizing Arch (no omega) • 424-166
- Size 4 Basic Distalizing Arch (no omega) • 424-167
- Size 5 Basic Distalizing Arch (no omega) • 424-168
- Size 6 Basic Distalizing Arch (no omega) • 424-169
- Size 7 Basic Distalizing Arch (no omega) • 424-170

Auxiliaries

Open Coil Spring

.010 x .045 Open Coil Spring
15" spool (Nitanium®) • 100-756

.010 x .045 Open Coil Spring
3' spool (Stainless Steel) • 108-105

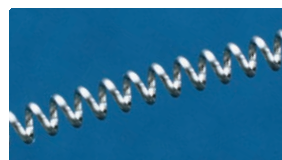

Nitanium® Variable Force Spring

Fixed spring for non-compliant patients who will not use their elastics.

(4 per pack) .020 x .100 • 100-695



Magnet Force System™

This molar distalizer ties into the molar bracket and bicuspid brackets to generate force. The polarity of the magnets is reversed so they push against each other with enough force to move molars distally. Two magnet spring assemblies per kit. • 424-200

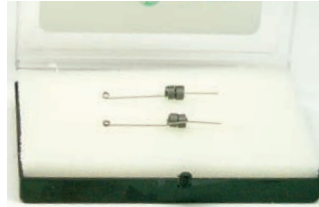
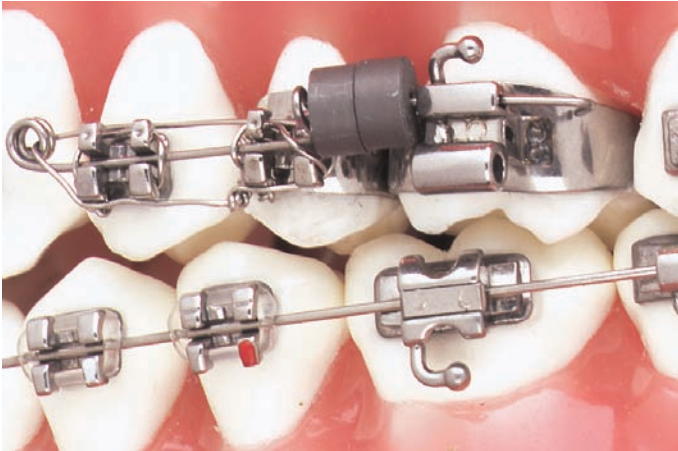

Ask for Your Free Copy of this Article on Magnet Distalization! "Pain-Free and Mobility-Free Orthodontics?"
Dr. Abraham Blechman • 999-152

K-Loop™ Molar Distalizing Appliance



Developed in Consultation with Dr. Varun Kalra

Used to distalize molars in a more bodily fashion as the special V-bend in the K-Loop™ moves both the crown and root distally. Made of CNA™ Beta III Titanium, the K-Loop™ produces gentle continuous forces for efficient and effective tooth movement. (5 per pack) • 034-000

Activation:

Step 1: Insert K-Loop™ into first molar tube and first premolar bracket. Place a mark just mesial to the molar tube and distal to the premolar bracket.

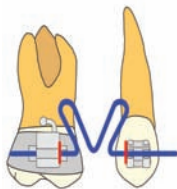

Step 2: Place 2.0mm high step bend 2.0mm distal to the molar mark and 2.0mm mesial to the premolar mark.



Step 3: Insert K-Loop™ in place and ligate into premolar bracket. Place a cinch back bend mesial to the premolar bracket as shown.

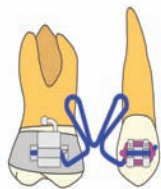

Ask for YOUR FREE COPY of Dr. Kalra's Article on the K-Loop™ Distalizing Appliance The K-Loop molar distalizing appliance. • 999-187

Titanium TWIN FORCE® With Titanium Clamps & Screws

- **High Quality Grade Titanium Clamps and Screws**
Reduces breakage and slippage
- **Square Screw Versus Hex Screw**
Allows tightening of clamp without stripping or loosening of screw
- **Laser Welding of All Components**
Insures that all working components function as a single unit – minimizing separation
- **Precision Machining for Precise Accuracy and Comfort**
The "Right Size" components provide a secure attachment every time and enhanced patient comfort

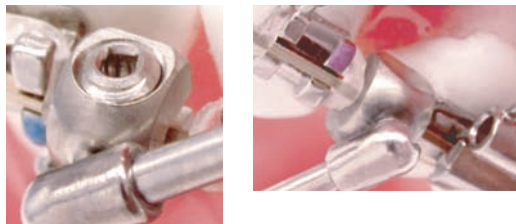

Original Version:
Small • 424-211Ti
Standard • 424-210Ti

Measuring for Original

1. Measure from the distal edge of the lower cuspid bracket to the distal end of the upper molar facebow tube.
2. If measurement is 29mm+ use the standard size. If measurement is less than 29mm, use the small size.

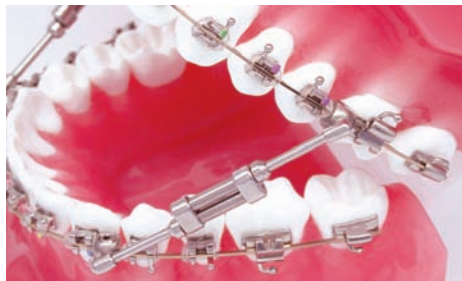
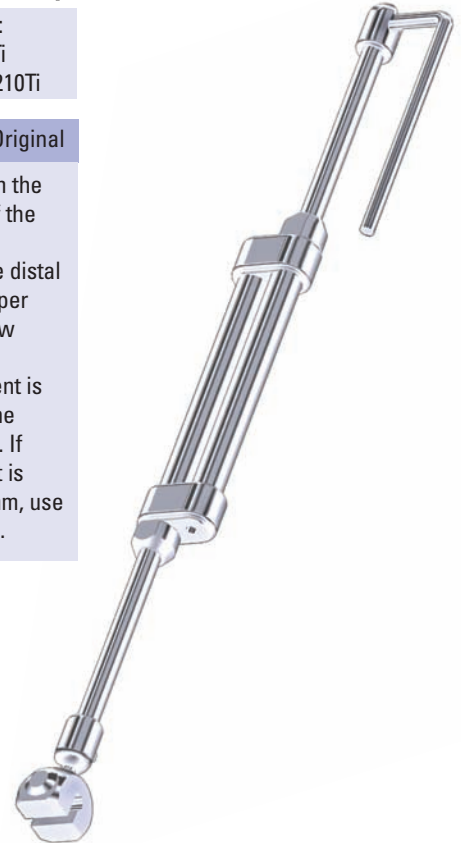

Ask for Your Free Copy of this Article!
"Twin Force™ Bite Corrector, Light Force and Patient Friendly"
– Dr. Maurice Corbett • 999-176

Ask for Your Free Copy of this Article!
"Class II Correction with the Twin Force Bite Corrector"
– Drs. Nanda, Rothenberg & Campbell • 999-197



TWIN FORCE® Screws
(4 per pack) • 424-218SC

Double Lock Version:
Small • 424-216Ti
Standard • 424-215Ti

Measuring for Double Lock

1. Measure from the distal edge of the lower cuspid bracket to the mesial end of the upper molar tube.
2. If measurement is 27mm+ use the standard size. If measurement is less than 27mm, use the small size.



TWIN FORCE® Tool • 424-213TI

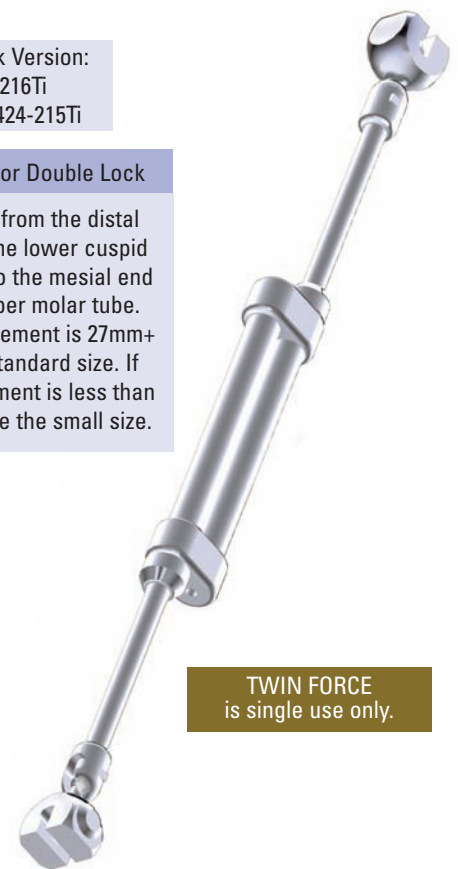

TWIN FORCE
is single use only.

Clark TRANSFORCE® Arch Developers



Upper and Lower Lingual Arch Developing Appliances

Developed in consultation with Dr. William Clark
(Inventor of the Clark Twin Block)

The TRANSFORCE® is available in two styles:

- The Transverse expands at the cuspids in both the upper and lower arches and is available in 2 upper and 2 lower sizes
- The Sagittal creates space by advancing the 3x3 mesially and is available in 3 upper and 3 lower sizes

Other Features:

- These appliances are excellent for mixed dentition arch development and are also great for adults. These devices are virtually invisible in adult arch development
- Nickel Titanium Springs generate approximately 200 grams of gentle biocompatible force
- Both are easy to fit and no lab work is required
- Appliances are preprogrammed for easy diagnosis and can be ordered in a starter assortment kit, or individually per each size
- Multiple sizes for upper and lower arch development
- Excellent for mixed dentition arch development
- Virtually invisible for adult arch development
- Treats all classes of malocclusions
- Force modules provide gentle biocompatible force

Ask for your FREE copy of these articles by Dr. Clark
WJO "Arch Development with TRANSFORCE APPLIANCES" • 999-202
JCO "TRANSFORCE Lingual Appliances for arch development" • 999-201

Transverse Expander

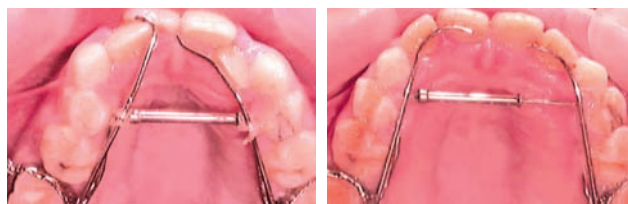
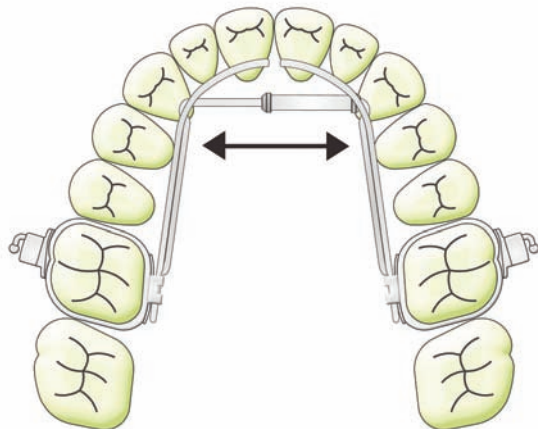

Before

After

TRANSFORCE® Transverse Expander

Description	Catalogue Number
Upper Transverse Size 1 (29mm)	424-335
Upper Transverse Size 2 (32mm)	424-336
Lower Transverse Size 1 (26mm)	424-345
Lower Transverse Size 2 (28mm)	424-346
Kit – Upper & Lower (1 each)	424-330
Lingual Arch Development Planner	424-330C

Transverse Lingual Arch Development Planner • 424-330C

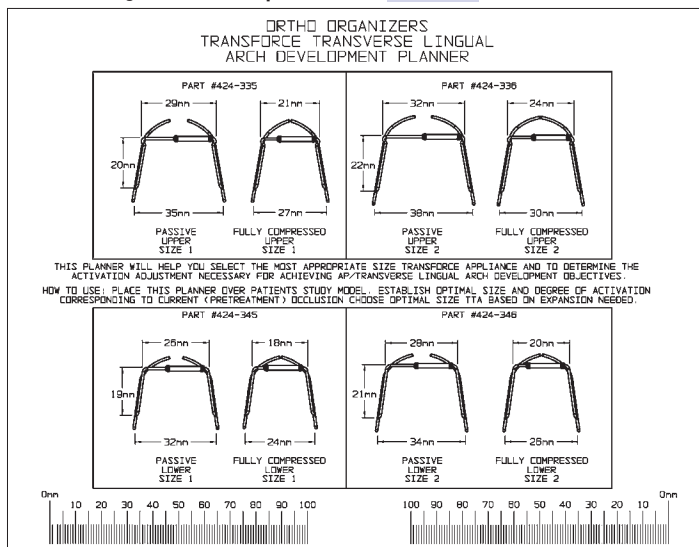

Sagittal Expander

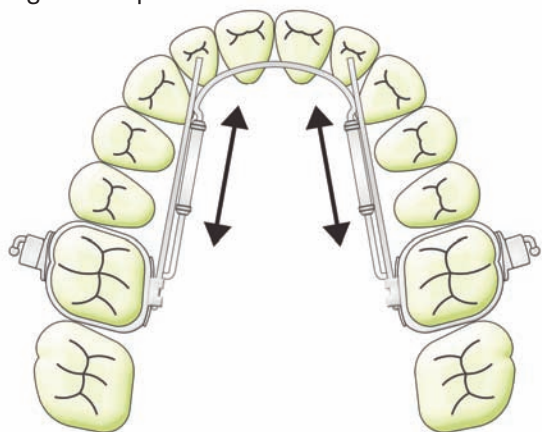

Before

After

TRANSFORCE® Sagittal Expander

Description	Catalogue Number
Upper Sagittal Size 0 (34mm)	424-304
Upper Sagittal Size 1 (36mm)	424-305
Upper Sagittal Size 2 (38mm)	424-306
Upper Sagittal Size 3 (40mm)	424-307
Lower Sagittal Size 0 (28mm)	424-314
Lower Sagittal Size 1 (30mm)	424-315
Lower Sagittal Size 2 (32mm)	424-316
Lower Sagittal Size 3 (34mm)	424-317
Kit – Upper & Lower (1 each)	424-300
Kit – Upper (1 each)	424-301
Kit – Lower (1 each)	424-311
Lingual Arch Development Planner	424-300C

Sagittal Lingual Arch Development Planner • 424-300C

